

Modify Select

View Templates

Visibility/ Graphics Filters Thin Lines

Show Hidden Lines Remove Hidden Lines Cut Profile

Render Render in Cloud Render Gallery

3D View Section Callout

Plan Views Elevation

Drafting View Duplicate View Legends

Schedules Scope Box

Sheet View

Switch Windows Close Hidden

User Interface

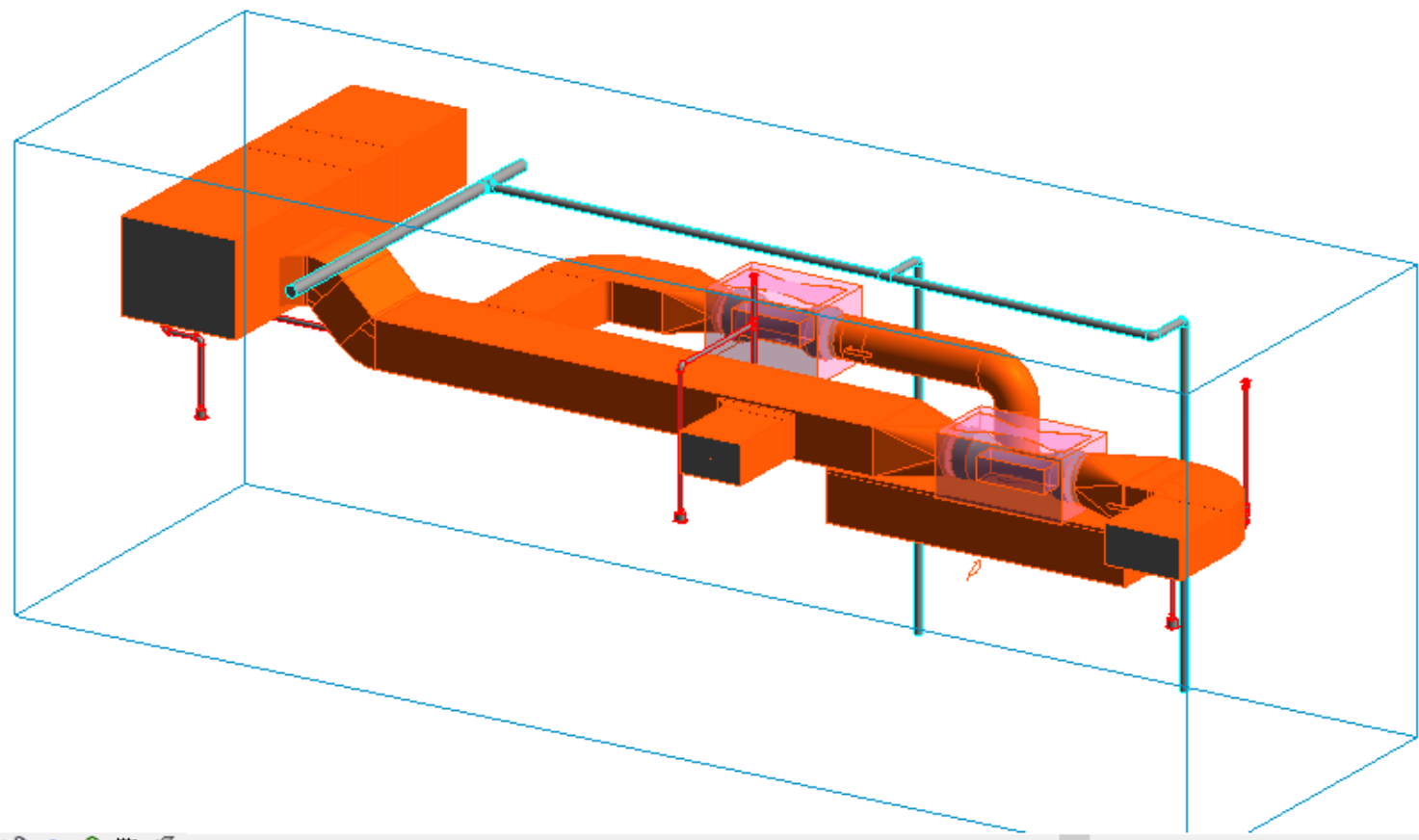

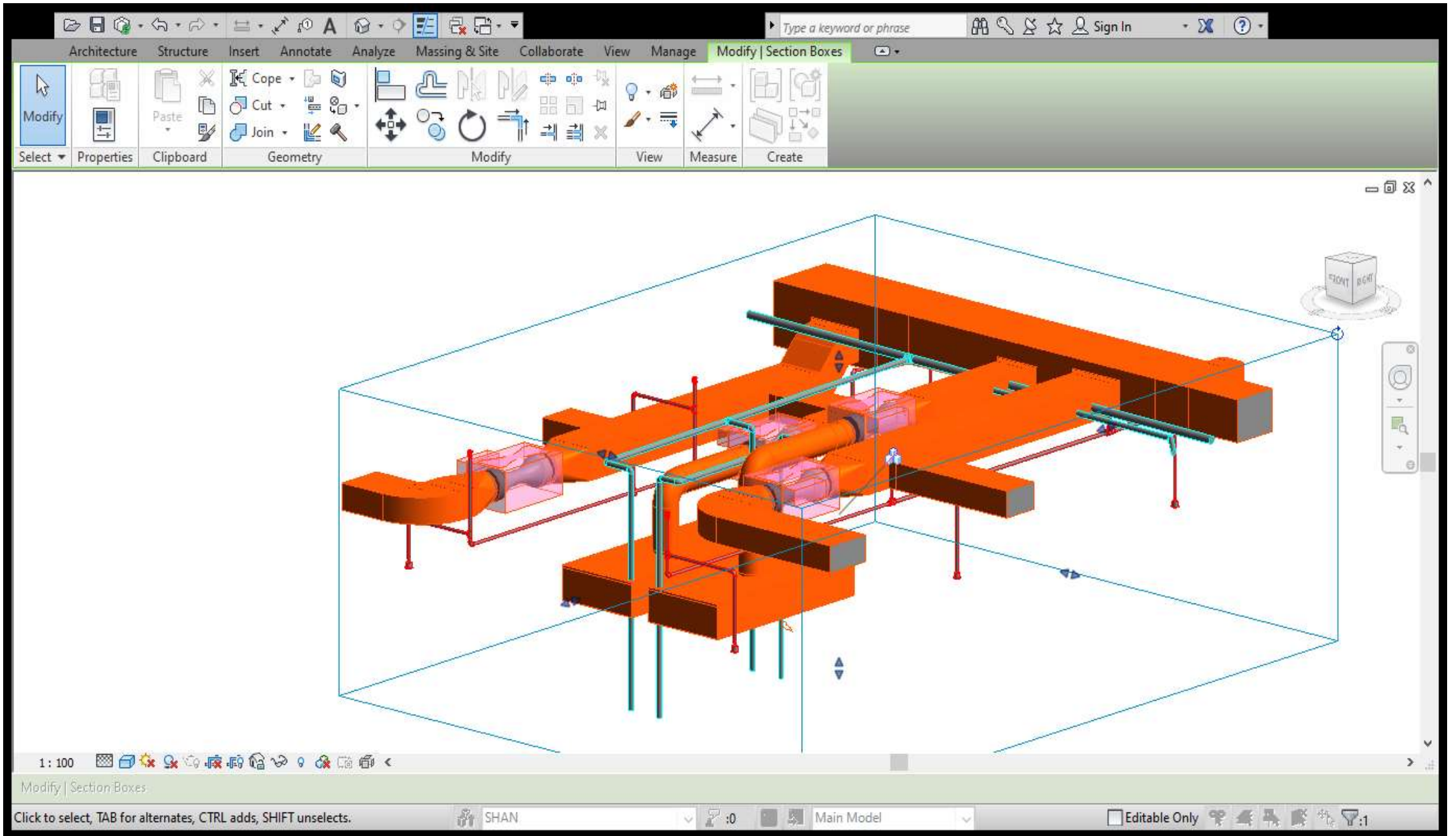

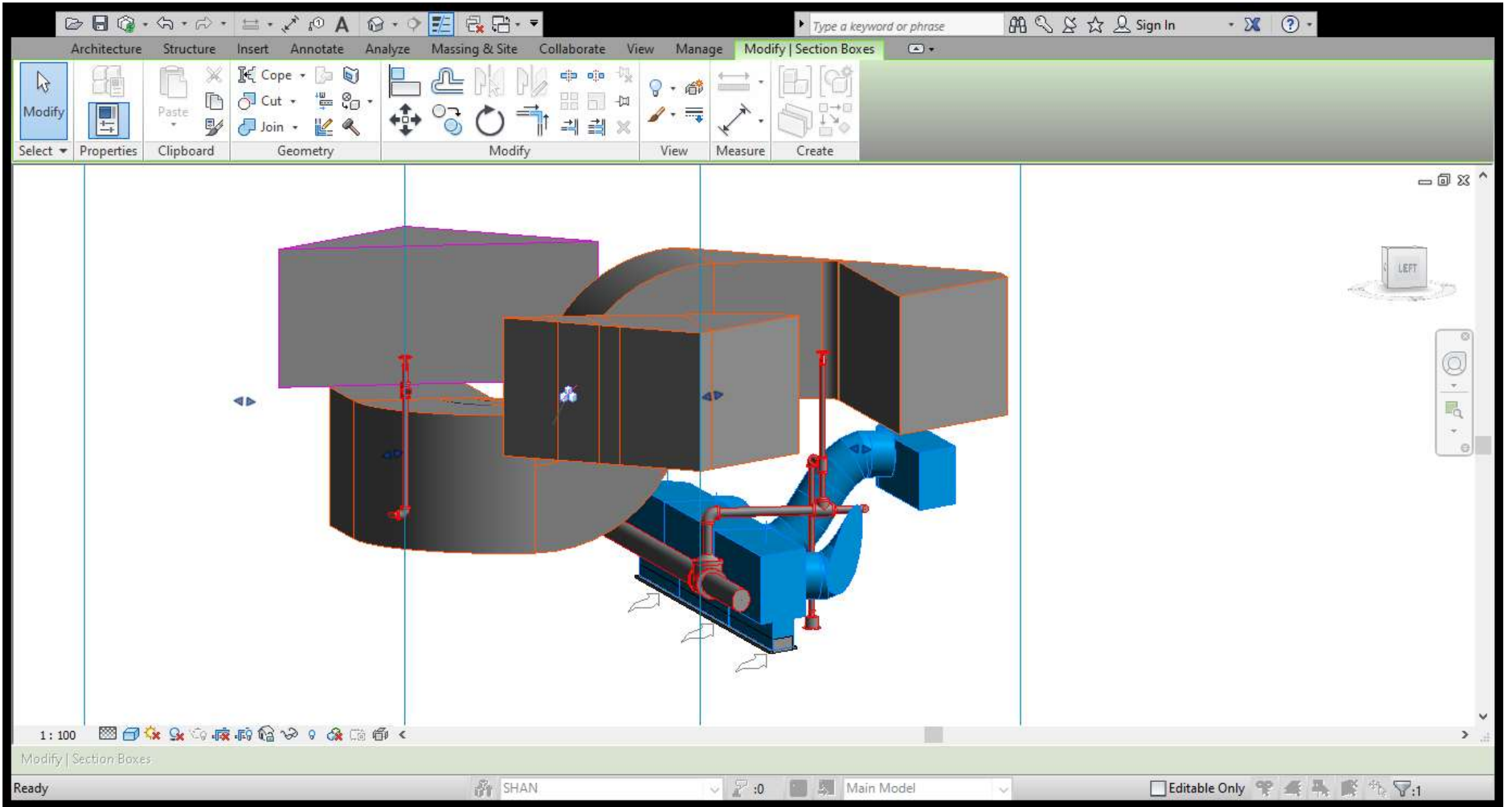



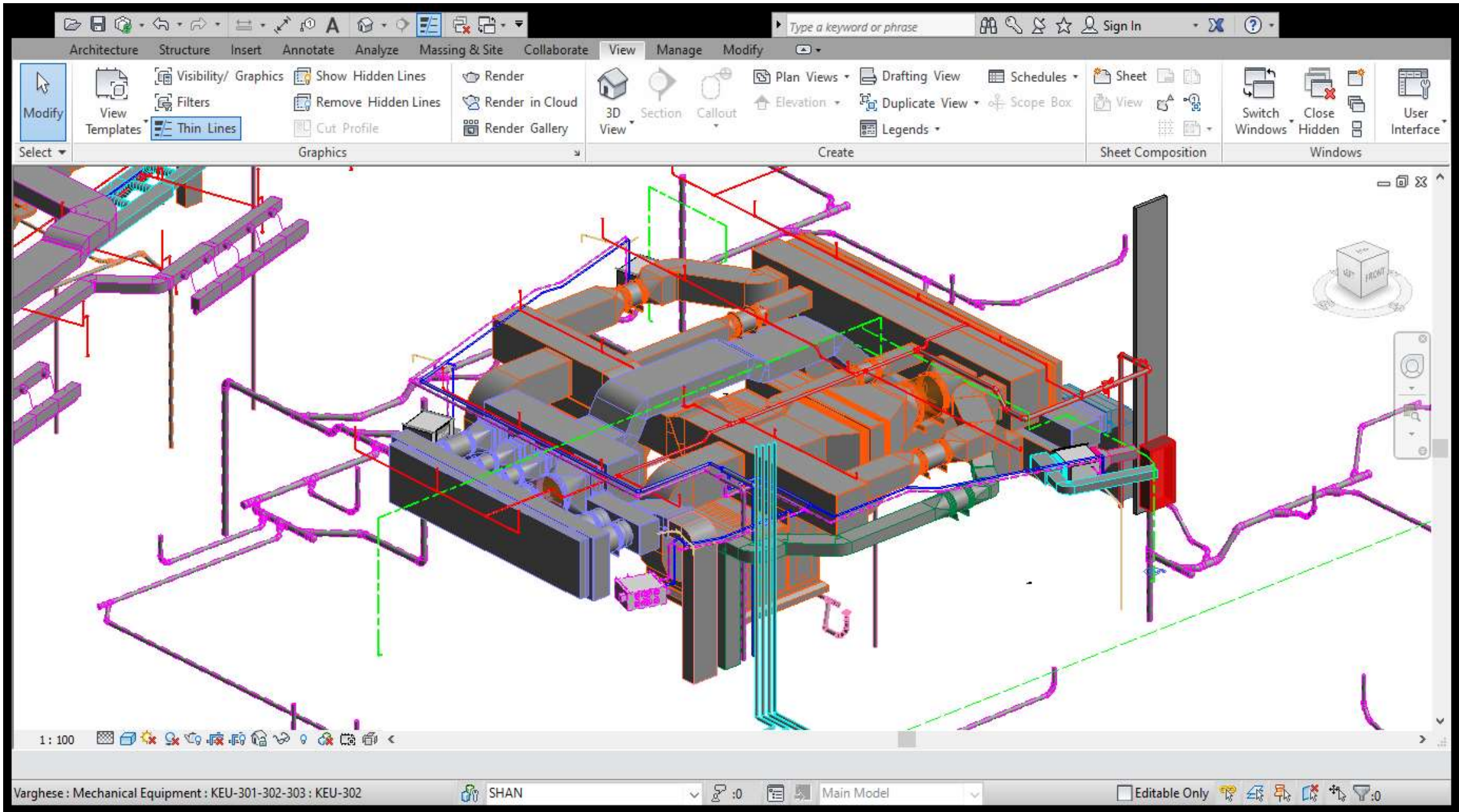



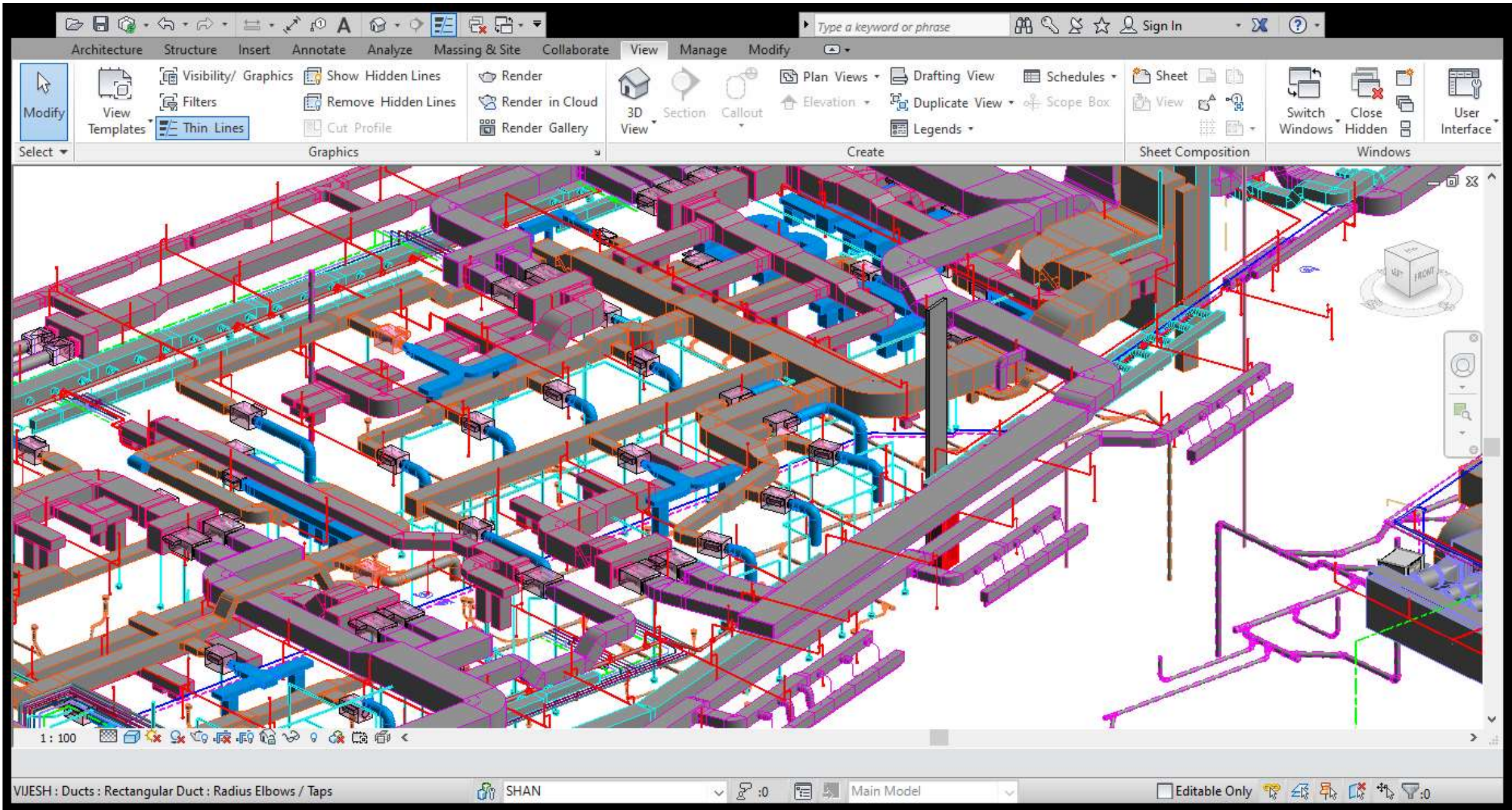

Architecture Structure Insert Annotate Analyze Massing & Site Collaborate View Manage Modify

Type a keyword or phrase Sign In

Modify Select

View Templates

Visibility/ Graphics Filters Thin Lines

Show Hidden Lines Remove Hidden Lines Cut Profile

Render Render in Cloud Render Gallery

3D View Section Callout

Plan Views Elevation

Drafting View Duplicate View Legends

Schedules Scope Box

Sheet View

Switch Windows Close Hidden

User Interface

Graphics Create Sheet Composition Windows

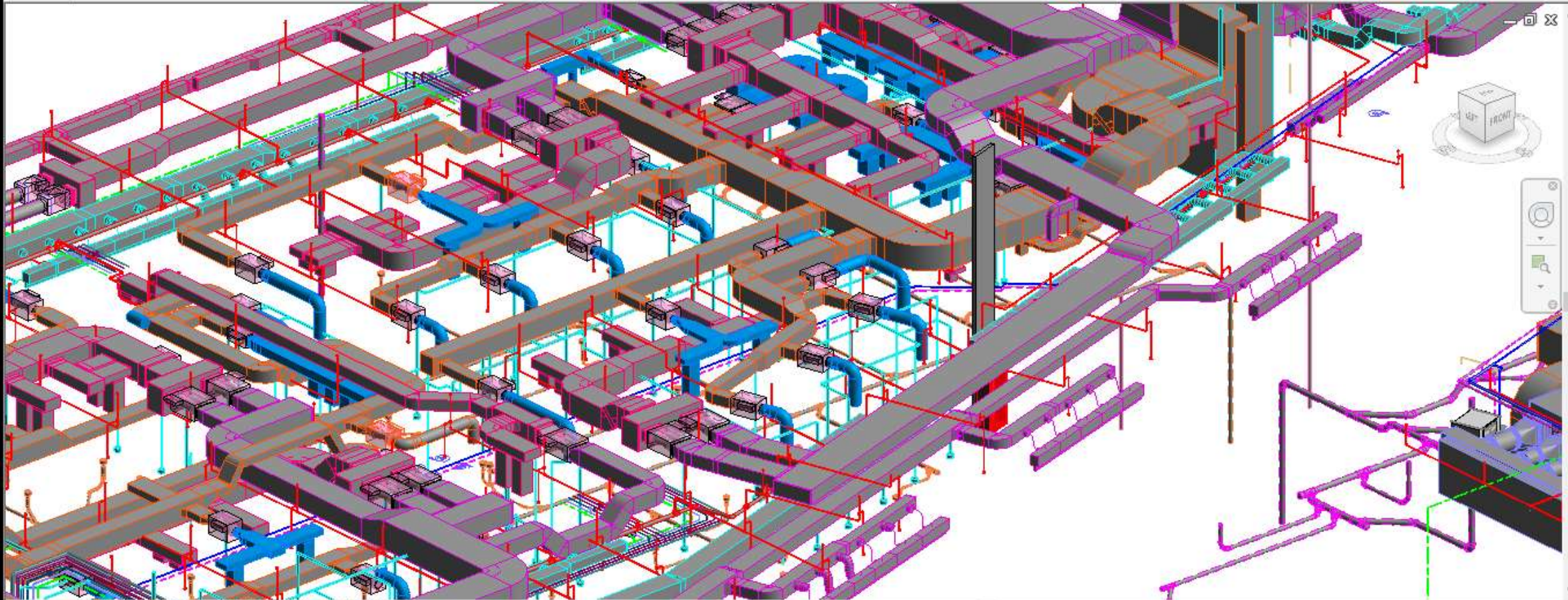

1:100

VIJESH : Ducts : Rectangular Duct : Radius Elbows / Taps

SHAN

Main Model

0

0

Editable Only



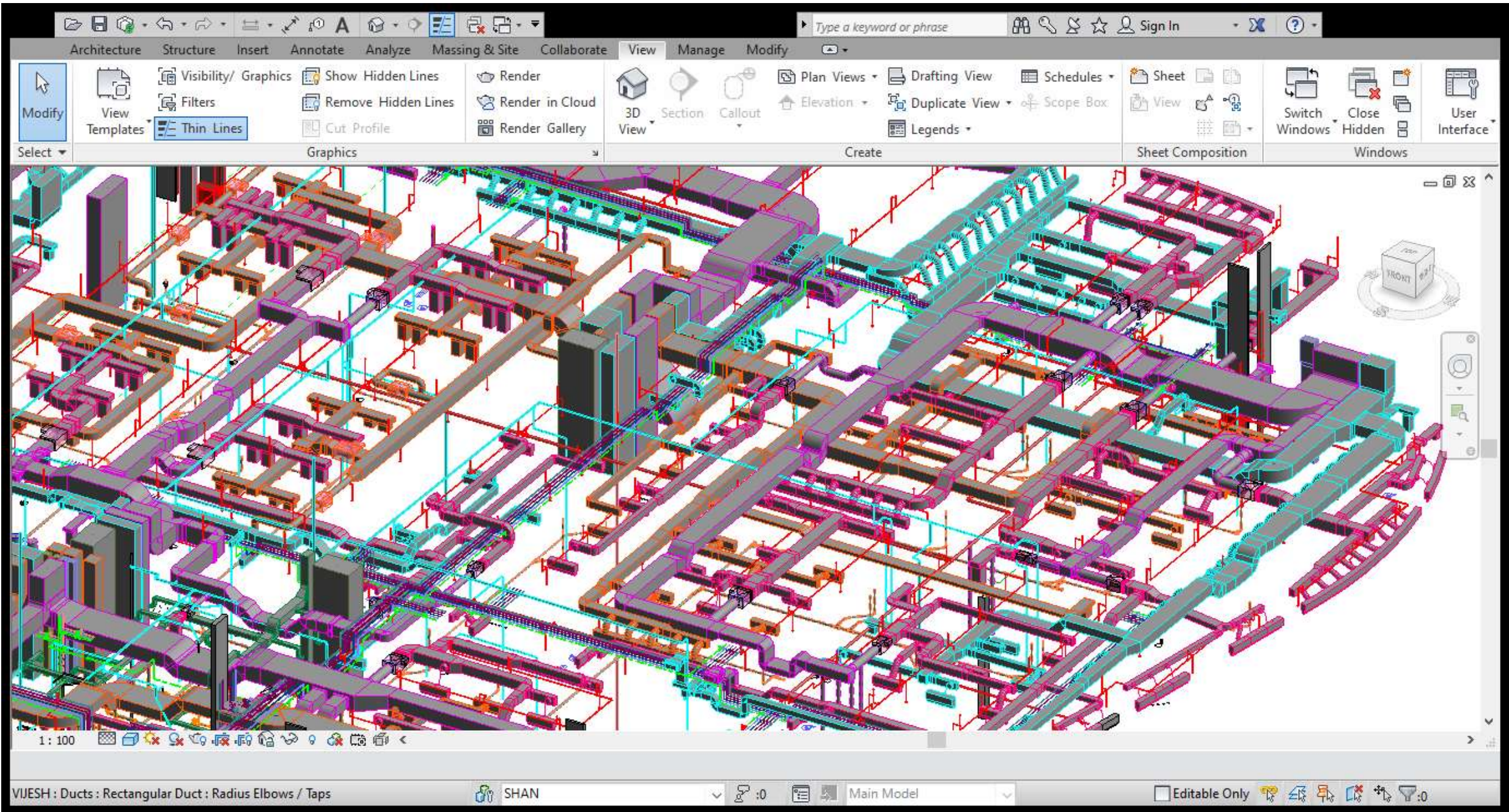



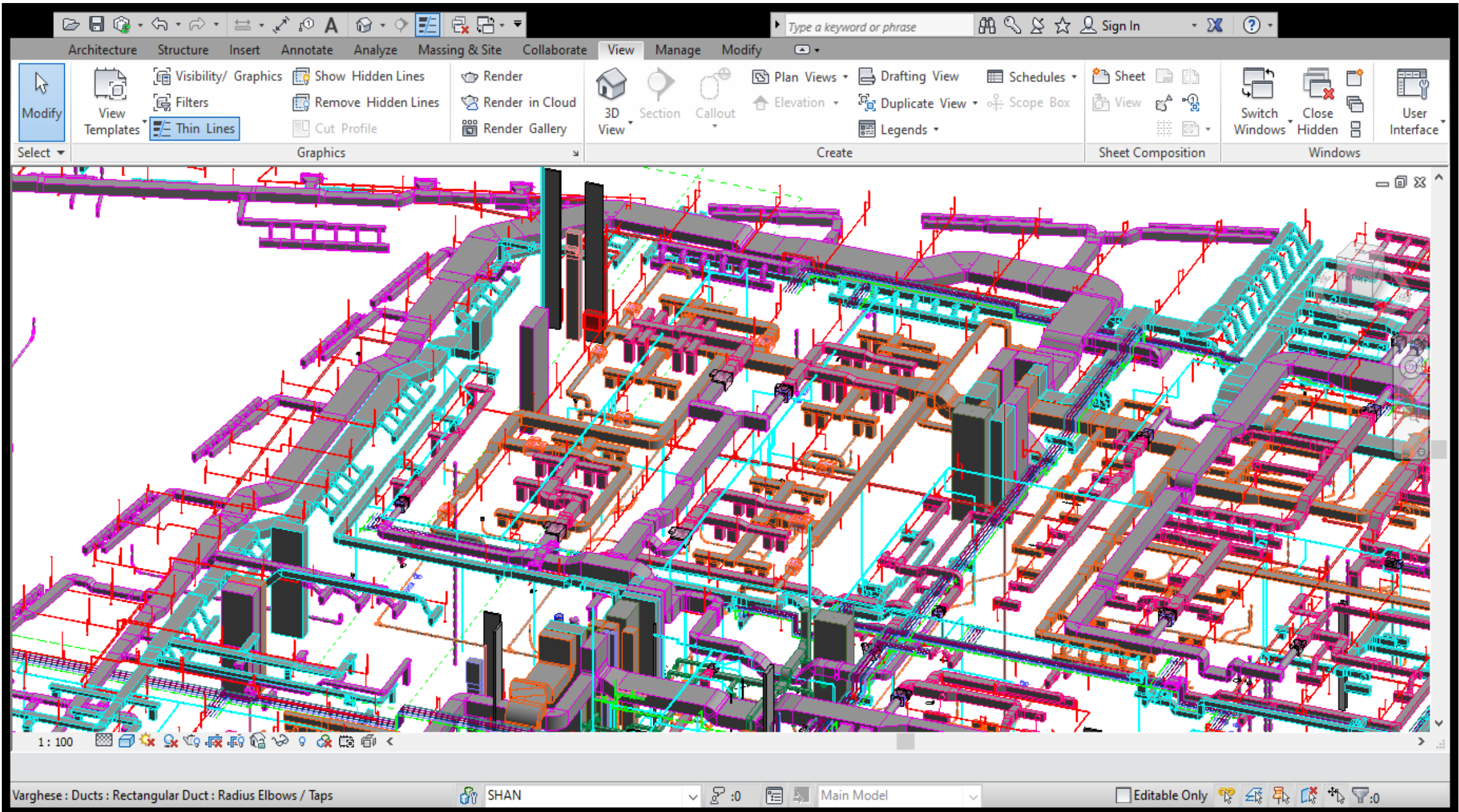

Modify Select

View Templates: Thin Lines

Visibility/ Graphics: Show Hidden Lines, Remove Hidden Lines, Cut Profile

Graphics

Render: Render, Render in Cloud, Render Gallery

3D View, Section, Callout

Plan Views, Elevation, Drafting View, Duplicate View, Legends

Create

Sheet, View, Sheet Composition

Switch Windows, Close Hidden, Windows

User Interface

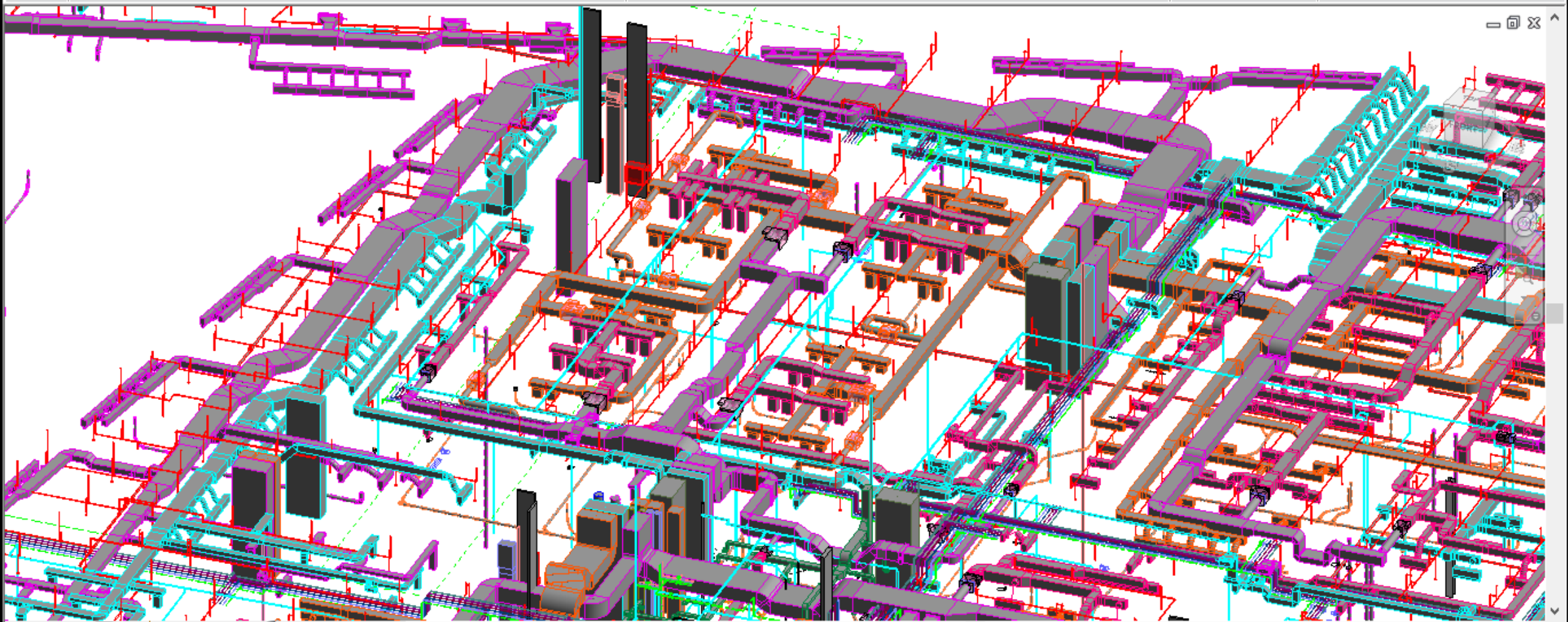



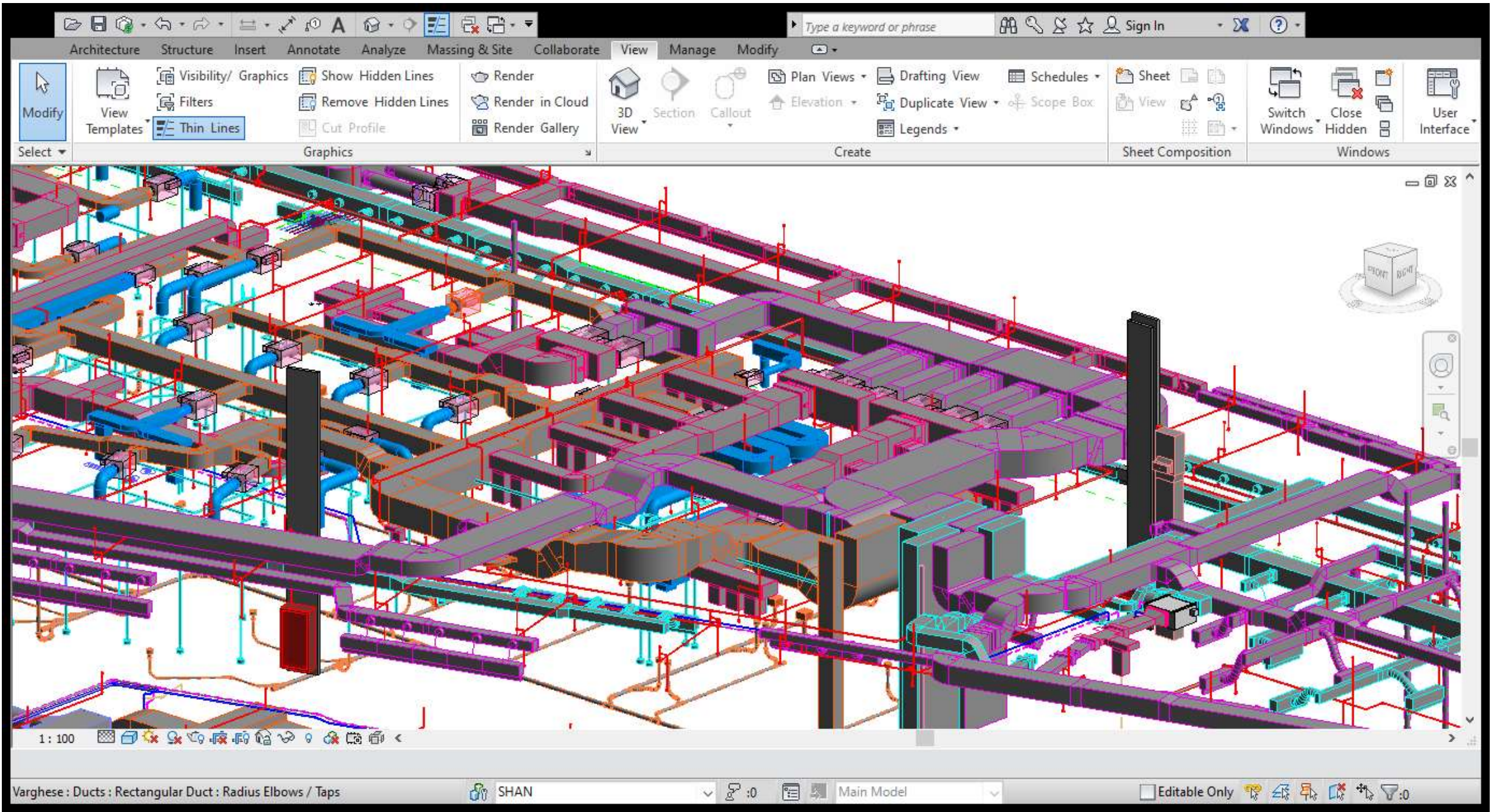



Architecture Structure Insert Annotate Analyze Massing & Site Collaborate View Manage Modify

Type a keyword or phrase Sign In

Modify Select

View Templates Thin Lines

Visibility/ Graphics Show Hidden Lines Remove Hidden Lines Cut Profile

Render Render in Cloud Render Gallery

3D View Section Callout

Plan Views Elevation

Drafting View Duplicate View Legends

Schedules Scope Box

Sheet View

Switch Windows Close Hidden

User Interface

Graphics Create Sheet Composition Windows

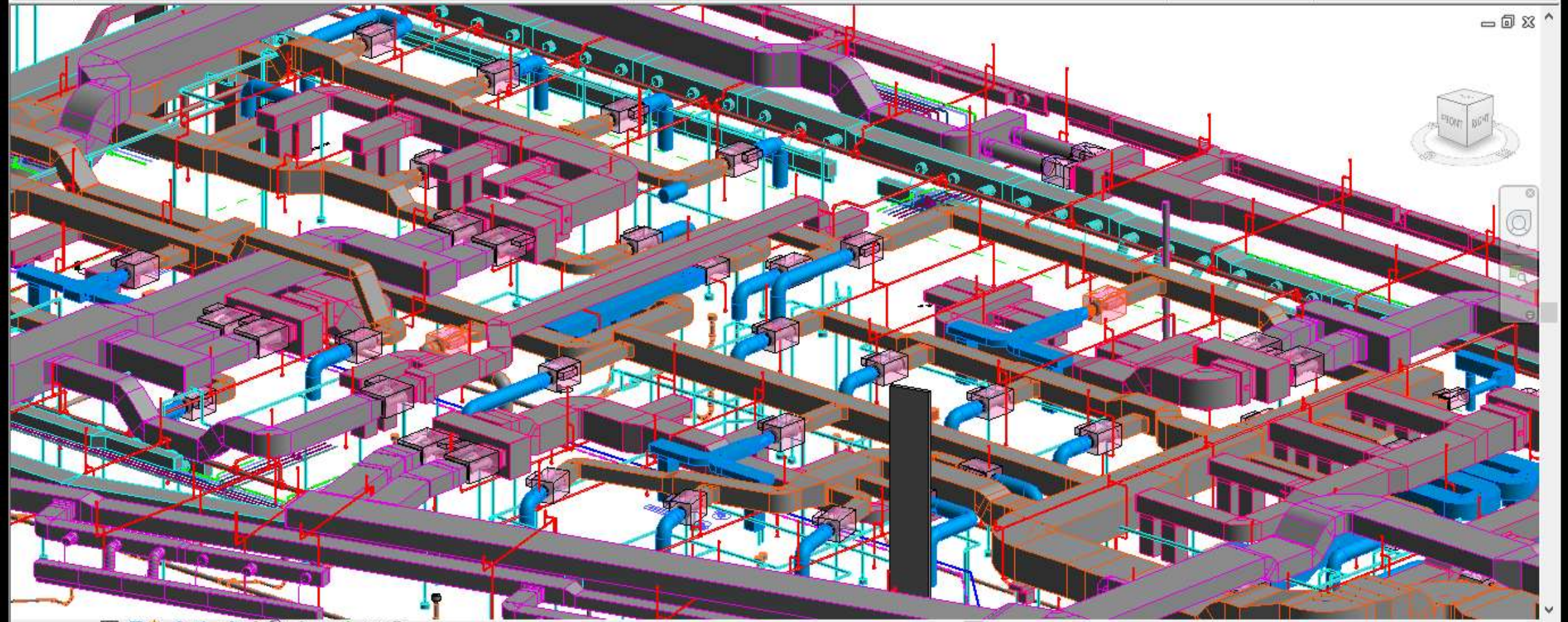

1 : 100

Varghese : Ducts : Rectangular Duct : Radius Elbows / Taps

SHAN

Main Model

Editable Only